

SEPARADORES DE CARRETA

COD. 71-00-02

UN. EMP. 5

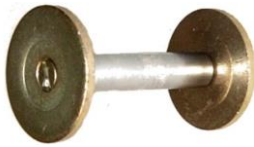

SEPARADOR CARRETA PEQUEÑO

COD. 71-00-03

UN. EMP. 5

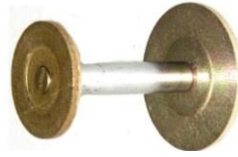

SEPARADOR CARRETA TIPO 30 GRANDE

COD. 71-00-05

UN. EMP. 5



SEPARADOR CARRETA TIPO 24
NPR / NQR / JAC / AGRALE

BALANCINES

UNIVERSAL

COD. 77-00-01

UN. EMP. 1

REF: B77-217



BALANCIN CON PASADOR DE 9/16"

Pasador : Ø 9/16"

COD. 77-00-02

UN. EMP. 1

REF: B77-124



BALANCIN CON PASADOR DE 5/8"

Pasador : Ø 5/8"

CHEVROLET

COD. 77-03-03

UN. EMP. 1



BALANCIN CON BUJE LUV 1600

BUJE: ↓ 38 mm Ø Ext: 32mm Ø Int: 18mm

Pasador : Ø18 mm

CHEVROLET

COD. 77-03-05

UN. EMP. 1



BALANCIN CON BUJE ISUZU LUV 2300
HB Original

BUJE 1: ↓ 41 mm Ø Ext: 30 mm Ø Int.: 18 mm

BUJE 2: ↓ 34 mm Ø Ext.: 30mm Ø Int.: 18 mm

Pasador : Ø18 mm

COD. 77-03-05C

UN. EMP. 1



BALANCIN CON BUJE ISUZU LUV 2300
Original - Cruzado

BUJE 1: ↓ 41 mm Ø Ext.: 30 mm Ø Int.:18 mm

BUJE 2: ↓ 34 mm Ø Ext.: 30 mm ØInt.: 18 mm

Pasador : Ø18 mm

COD. 77-03-09

UN. EMP. 1



BALANCIN CON BUJE ISUZU LUV 2300 /
TROOPER - Largo

BUJE 1: ↓ 41 mm Ø Ext.: 30 mm Ø Int.: 18 mm

BUJE 2: ↓ 34 mm Ø Ext.: 30 mm Ø Int.: 18 mm

Pasador : Ø18 mm

COD. 77-03-04

UN. EMP. 1



BALANCIN CON BUJE ISUZU / TROOPER

BUJE 1: ↓ 41 mm Ø Ext.: 30 mm Ø Int.: 18 mm

BUJE 2: ↓ 41 mm Ø Ext.: 30 mm Ø Int.: 18 mm

Pasador : Ø18 mm

COD. 77-03-06

UN. EMP. 1



BALANCIN CON BUJE SAMURAI (Muelle corto)

BUJE: ↓ 36 mm Ø Ext. 30 mm Ø Int. 12.4 mm

Pasador Ø Ext. 12.4 mm

Ø Int. 18 mm Ø Ext. 39.8 mm ↔ 38.3 mm

COD. 77-23-01

UN. EMP. 1



BALANCIN CON BUJE SUZUKI

BUJE: ↓ 36 mm Ø Ext. 30 mm Ø Int.12.4 mm

Pasador Ø Ext. 12.4 mm

COD. 77-23-02	UN. EMP. 1
	
BALANCIN CON BUJE SUZUKI (Original)	
BUJE: \updownarrow 36 mm \varnothing Ext. 30 mm \varnothing Int. 12.4 mm Pasador \varnothing Ext. 12.4 mm	

COD. 77-03-10	UN. EMP. 1
	
BALANCIN CON BUJE TRAS. NHR	
BUJE: \updownarrow 38.3 mm \varnothing Ext. 42.4 mm \varnothing Int. 22.7 mm Pasador \varnothing 22 mm	

COD. 77-03-08	UN. EMP. 1
	
BALANCIN CON BUJE DEL. NKR	
BUJE: \updownarrow 38 mm \varnothing Ext. 42.4 mm \varnothing Int. 22.7 mm Pasador \varnothing 22 mm	

COD. 77-03-07	UN. EMP. 1
	
BALANCIN CON BUJE TRAS. NKR	
BUJE: \updownarrow 73.3 mm \varnothing Ext. 40 mm \varnothing Int. 16 mm Pasador \varnothing 16 mm	

COD. 77-03-01	UN. EMP. 1
	
BALANCIN CON BUJE DEL. NPR	
BUJE: \updownarrow 73.1 mm \varnothing Ext. 42.3 mm \varnothing Int. 16.4 mm Pasador \varnothing 16 mm	

COD. 77-03-02	UN. EMP. 1
	
BALANCIN CON BUJE TRAS. NPR	
BUJE: \updownarrow 45 mm \varnothing Ext. 54.3 mm \varnothing Int. 16.4 mm Pasador \varnothing Ext. 22 mm	

DAHIATSU

COD. 77-05-02	UN. EMP. 1
OEM 04481-87601	
	
BALANCIN CON BUJE F10 F20 / FERZA	
BUJE 1: \updownarrow 41.5 mm \varnothing Ext. 31 mm \varnothing Int. 15 mm BUJE 2: \updownarrow 41.5 mm \varnothing Ext. 36 mm \varnothing Int. 18 mm Pas. Largo \varnothing 18 mm Pas. Corto \varnothing 16 mm	

COD. 77-05-01	UN. EMP. 1
	
BALANCIN CON BUJE TRAS. DELTA	
BUJE 1: \updownarrow 57 mm \varnothing Ext. 45.5 mm \varnothing Int. 30 mm BUJE 2: \updownarrow 83 mm \varnothing Ext. 45 mm \varnothing Int. 18 mm Pas. Largo \varnothing 30 mm Pas. Corto 18 mm	

COD. 77-05-03	UN. EMP. 1
	
BALANCIN CON BUJE DEL. DELTA (MN)	
BUJE 1: \updownarrow 42 mm \varnothing Ext. 37 mm \varnothing Int. 25.4 mm BUJE 2: \updownarrow 71.5 mm \varnothing Ext. 35 mm \varnothing Int. 16 mm Pas. Largo \varnothing 25.4 mm Pas. Corto \varnothing 16 mm	

HYUNDAI

MAZDA

MITSUBISHI

COD. 77-09-01	UN. EMP. 1
	
BALANCIN CON BUJE H100 DIESEL / HI 2700	
BUJE 1: \updownarrow 50 mm \varnothing Ext. 28 mm \varnothing Int. 16 mm BUJE 2: \updownarrow 40 mm \varnothing Ext. 28.5 mm \varnothing Int. 16 mm Pas. Largo \varnothing 16 mm - Pas. Corto \varnothing 16 mm	

COD. 77-16-01	UN. EMP. 1
	
BALANCIN CON BUJE MAZDA B2000/B2200/B2600	
BUJE 1: \updownarrow 43 mm \varnothing Ext. 32 mm \varnothing Int. 18 mm BUJE 2: \updownarrow 37 mm \varnothing Ext. 33 mm \varnothing Int. 18 mm Pas. Largo \varnothing 18 mm - Pas. Corto \varnothing 18 mm	

COD. 77-19-02	UN. EMP. 1
	
BALANCIN CON BUJE CANTER/HYUNDAI HD (72...)	
BUJE 1: \updownarrow 44.5 mm \varnothing Ext. 40 mm \varnothing Int. 23 mm PASADOR: \varnothing 22.2 mm	

MITSUBISHI

NISSAN

COD. 77-19-03	UN. EMP. 1
	
BALANCIN DEL. PARTE TRAS. CANTER (04...)	
PASADOR 1: \varnothing Ext.. 22 mm \leftrightarrow 120 mm PASADOR 2: \varnothing Ext.. 22 mm \leftrightarrow 102 mm	

COD. 77-19-01	UN. EMP. 1
	
BALANCIN CON BUJE MONTERO L200-300	
BUJE 1: \updownarrow 51 mm \varnothing Ext. 28 mm \varnothing Int. 16 mm BUJE 2: \updownarrow 40.5 mm \varnothing Ext. 28 mm \varnothing Int. 16 mm Pas. 1: \varnothing 16 mm - Pas. 2: \varnothing 16 mm	

COD. 77-20-01	UN. EMP. 1
	
BALANCIN CON BUJE D21 / URVAN (Muelle largo)	
BUJE: \updownarrow 37 mm \varnothing Ext. 33 mm \varnothing Int. 18 mm Pasador: \varnothing Ext. 18 mm	

NISSAN

COD. 77-20-02	UN. EMP. 1
	
BALANCIN CON BUJE D21	
BUJE: ↑ 37 mm Ø Ext. 33 mm Ø Int. 18 mm Pasador: Ø Ext. 18 mm	

COD. 77-20-04	UN. EMP. 1
	
BALANCIN CON BUJE D21 (Buje RB210)	
BUJE 1: ↑ 37 mm Ø Ext. 33 mm Ø Int. 18 mm BUJE 2: ↓ 70 mm Ø Ext. 33 mm Ø Int. 11 mm Pasador 1: ØExt. 18 mm - Pasador 2: ØExt. 11mm	

COD. 77-20-05	UN. EMP. 1
	
BALANCIN NISSAN D-21 CON BUSHING (Buje RB210)	
BUJE 1: ↑ 66 mm Ø Ext. 33 mm Ø Int. 12 mm BUJE 2: ↓ 36 mm Ø Ext. 33 mm Ø Int. 20 mm Pasador 1: ØExt. 12 mm - Pasador 2: ØExt. 20mm	

TOYOTA

COD. 77-24-04 OEM 04483-35050	UN. EMP. 1
	
BALANCIN CON BUJE TRAS. HILUX 2WD / 4RUNNER (89-92) -Largo LN 1111 - 135 / RN 110 - 135	
BUJE 1: ↑ 33 mm Ø Ext. 30 mm Ø Int. 18 mm BUJE 2: ↓ 48 mm Ø Ext. 30 mm Ø Int. 18 mm PAS. 1 Ø 18 mm PAS. 2 Ø18mm	

COD. 77-24-05 OEM 04481-35040	UN. EMP. 1
	
BALANCIN CON BUJE DEL. HILUX 4WD (79-86) / 4RUNNER (84-86) RN 105 G / LN 106 D / YN 106G	
BUJE 1: ↑ 53 mm Ø Ext. 30mm Ø Int. 18 mm BUJE 2: ↓ 40 mm Ø Ext. 30mm Ø Int. .18 mm PAS. 1 Ø 18 mm PAS. 2 Ø18mm	

COD. 77-24-06 OEM 04483-35040	UN. EMP. 1
	
BALANCIN CON BUJE TRAS. HILUX (79-89) / 4RUNNER (84-89) RN 105 / LN 106 / YN 106	
BUJE 1: ↑ 40 mm Ø Ext. 30.5 mm Ø Int. 18 mm BUJE 2: ↓ 32 mm Ø Ext. 30.5 mm Ø Int. 18 mm PAS. 1 Ø18 mm PAS. 2 Ø18 mm	

COD. 77-24-07 OEM 04483-35060	UN. EMP. 1
	
BALANCIN CON BUJE TRAS. HILUX 4WD (89-92)/ 4RUNNER 4WD (89-92) / TACOMA (95)	
BUJE 1: ↑ 48 mm Ø Ext. 30.5 mm Ø Int. 18 mm BUJE 2: ↓ 66 mm Ø Ext. 40 mm Ø Int. 15 mm PAS. 1 Ø18 mm PAS. 2 Ø14.3 mm	

COD. 77-24-01 OEM 04483-60060	UN. EMP. 1
	
BALANCIN CON BUJE DEL. - TRAS. LAND CRUISER FJ75 - BJ40 / 4.5 (80)	
BUJE 1: ↑ 47 mm Ø Ext. 40 mm Ø Int. 18 mm BUJE 2: ↓ 47 mm Ø Ext. 40 mm Ø Int. 18 mm PAS. 1 Y 2 : Ø 18 mm	

COD. 77-24-02 OEM 04481-60020	UN. EMP. 1
	
BALANCIN CON BUJE LAND CRUISER BJ42 - BJ60 - BJ70 (81-87)	
BUJE 1: ↑ 43 mm Ø Ext. 35 mm Ø Int. 18 mm BUJE 2: ↓ 43 mm Ø Ext. 35 mm Ø Int. 18 mm PAS. 1 Y 2 : Ø 18 mm	

COD. 77-24-03 OEM 04481-60011	UN. EMP. 1
	
BALANCIN CON BUJE DEL. LAND CRUISER (...80)	
BUJE 1: ↑ 39 mm Ø Ext. 26mm Ø Int. 16 mm BUJE 2: ↓ 39 mm Ø Ext. 26mm Ø Int. 16 mm PAS. 1 Y 2 : Ø 16 mm	

COD. 77-24-08 OEM 04481-60011	UN. EMP. 1
	
BALANCIN TOYOTA VIGO / HILUX TRAS.	
BUJE 1: ↑ 53.5 m Ø Ext. 30mm Ø Int. 20 mm BUJE 2: ↓ 32 mm Ø Ext. 30mm Ø Int. 20 mm PAS. 1 Ø20 mm Y 2: Ø 20 mm	

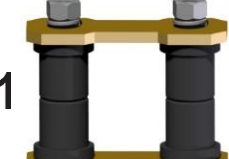
COD. 77-24-09 OEM	UN. EMP. 1
	
BALANCIN TOYOTA 4.5 DELANTERO (CORTO)	
BUJE 1: ↑ 44 mm Ø Ext. 35mm Ø Int. 18 mm BUJE 2: ↓ 44 mm Ø Ext. 35mm Ø Int. 18 mm PAS. 1 Ø18 mm Y 2: Ø 18 mm	

TOYOTA

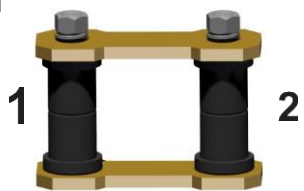
COD. 77-24-10	UN. EMP. 1
OEM	
	
BALANCIN TOYOTA 4.5 TRASERO (LARGO)	
BUJE 1: \updownarrow 44 mm	\emptyset Ext. 35mm \emptyset Int. 18 mm
BUJE 2: \updownarrow 44 mm	\emptyset Ext. 35mm \emptyset Int. 18 mm
PAS. 1 \emptyset 18 mm Y 2: \emptyset 18 mm	

CHEVROLET

<p>COD. 77B-03-03 UN. EMP. 10</p>  <p>BUJE BALANCIN LUV 1600</p> <p>∅ Int. 18 mm ∅ Ext. 39.8 mm ↔ 38.3 mm</p>	<p>COD. 77B-03-05 UN. EMP. 10</p>  <p>BUJE BALANCIN LUV 2300 - Original</p> <p>∅ Int. 18 mm ∅ Ext. 35.5 mm ↔ 35 mm</p>	<p>COD. 77B-03-09 UN. EMP. 10</p>  <p>BUJE BALANCIN LUV 2300 - Platina larga</p> <p>∅ Int. 18 mm ∅ Ext. 35.5 mm ↔ 35 mm</p>
<p>COD. 77B-03-04 UN. EMP. 10</p>  <p>BUJE BALANCIN ISUZU TROOPER</p> <p>∅ Int. 18 mm ∅ Ext. 35.5 mm ↔ 35 mm</p>	<p>COD. 77B-03-06 UN. EMP. 10</p>  <p>BUJE BALANCIN SAMURAI</p> <p>∅ Int. 12.4 mm ∅ Ext. 36 mm ↔ 36.6 mm</p>	<p>COD. 77B-23-01 UN. EMP. 10</p>  <p>BUJE BALANCIN SUZUKI</p> <p>∅ Int. 12.4 mm ∅ Ext. 36 mm ↔ 36 mm</p>
<p>COD. 77B-23-02 UN. EMP. 10</p>  <p>BUJE BALANCIN SUZUKI - Platina Larga</p> <p>∅ Int. 12.4 mm ∅ Ext. 36 mm ↔ 36.6 mm</p>	<p>COD. 77B-03-10 UN. EMP. 10</p>  <p>BUJE BALANCIN TRAS. NHR</p> <p>∅ Int. 22.5 mm ∅ Ext. 55.3 mm ↔ 38 mm</p>	<p>COD. 77B-03-08 UN. EMP. 10</p>  <p>BUJE BALANCIN DEL. NKR / HYUNDAI COUNTY TRAS.</p> <p>∅ Int. 22.5 mm ∅ Ext. 42.4 mm ↔ 39 mm</p>
<p>COD. 77B-03-07 UN. EMP. 10</p>  <p>BUJE BALANCIN TRAS. NKR</p> <p>∅ Int. 16mm ∅ Ext. 40 mm ↔ 73.3 mm</p>	<p>COD. 77B-03-01 UN. EMP. 10</p>  <p>BUJE BALANCIN DEL. NPR</p> <p>∅ Int. 16.4 mm ∅ Ext. 42.3 mm ↔ 73.1 mm</p>	<p>COD. 77B-03-02 UN. EMP. 10</p>  <p>BUJE BALANCIN TRAS. NPR</p> <p>∅ Int. 16.4 mm ∅ Ext. 54.3 mm ↔ 45 mm</p>
<p>COD. 77B-03-11 UN. EMP. 10</p>  <p>BUJE PASADOR NPR MOD. 97-99/2000 TRA PARTE DELANTERA (RB-440)</p> <p>∅ Int. 18 mm ∅ Ext. 42.5 mm ↔ 81 mm</p>	<p>COD. 17A-03-02 UN. EMP. 10</p>  <p>BUJE NPR MOD. NUEVO</p> <p>∅ Int. 18 mm ∅ Ext. 42 mm ↔ 81 mm</p>	

DAHIATSU

<p>COD. 77B-05-02C UN. EMP. 10</p>  <p>BUJE BALANCIN DAHIATSU CAMPERO - Corto</p> <p>∅ Int. 18 mm ∅ Ext. 36 mm ↔ 35 mm</p>	<p>COD. 77B-05-02L UN. EMP. 10</p>  <p>BUJE BALANCIN DAHIATSU CAMPERO - Largo</p> <p>∅ Int. 15 mm ∅ Ext. 31 mm ↔ 41.5 mm</p>	<p>COD. 77B-05-03 UN. EMP. 10</p>  <p>BUJE BALANCIN DEL. DAHIATSU DELTA (MN)</p> <p>∅ Int. 25.4mm ∅ Ext. 37mm ↔ 42 mm</p>
---	---	--

COD. 17-00-10 REF. 90043-85047	UN. EMP. 20
	
BUJE MUELLE DAIHATSU DELTA V12H-V24T-V22-V26 (TODOS)	
∅ Int. 25 mm ∅ Ext. 37 mm ↔ 42 mm	

COD. 77B-05-01	UN. EMP. 10
	
BUJE BALANCIN TRAS. DAIHATSU DELTA Caucho	
∅ Int. 18 mm ∅ Ext. 45.5 mm ↔ 57 mm	

COD. 77B-05-01CM	UN. EMP. 10
	
BUJE BALANCIN TRAS. DAIHATSU DELTA Caucho - Metal	
∅ Int. 18 mm ∅ Ext. 35 mm ↔ 83 mm	

HONDA	HYUNDAI
--------------	----------------

COD. 17A-28-01	UN. EMP. 10
	
BUJE BALANCIN NISSAN D-21 (RB-210)	
∅ Int. 12 mm ∅ Ext. 32 mm ↔ 35 mm	

COD. 17A-09-01	UN. EMP. 10
	
BUJE HYUNDAI COUNTY	
∅ Int. 19.5 mm ∅ Ext. 60 mm ↔ 46 mm	

KIA

COD. 17-12-01	UN. EMP. 10
	
BUJE SUSPENSION HYUNDAI ACCENT - KIA RIO	
∅ Int. 12.2mm ∅ Ext. 32.5 mm ↔ 53 mm	

MAZDA

COD. 77B-16-01C	UN. EMP. 10
	
BUJE BALANCIN MAZDA - Corto	
∅ Int. 18 mm ∅ Ext. 42.2 mm ↔ 37.7 mm	

COD. 77B-16-01L	UN. EMP. 10
	
BUJE BALANCIN MAZDA - Largo	
∅ Int. 18 mm ∅ Ext. 40 mm ↔ 44.5 mm	

COD. 17A-16-01	UN. EMP. 10
	
BUJE DEL. AMORTIGUADOR MAZDA BT50/FORD RANGER	
∅ Int. 13.3 mm ∅ Ext. 40 mm ↔ 38 mm	

MITSUBISHI

COD. 77B-19-02 OEM 90385-23037	UN. EMP. 10
	
BUJE BALANCIN TRAS. MITSUBISHI CANTER / TOYOTA DYNA (86-03) / COASTER (82-93)/ NKR	
∅ Int. 23mm ∅ Ext.. 40 mm ↔ 47 mm	

COD. 77B-19-02C OEM 8-94249-427-0	UN. EMP. 10
	
BUJE BALANCIN MITSUBISHI / TOYOTA DYNA / ISUZU NKR	
∅ Int. 23 mm ∅ Ext.. 43 mm ↔ 47 mm	

COD. 77C-19-02 OEM 8-94249-427-0	UN. EMP. 10
	
CASQUETE BUJE BALANCIN MITSUBISHI / TOYOTA DYNA / ISUZU NKR	
∅ Int. 39.2mm ∅ Ext.. 43 mm ↔ 36 mm	

MITSUBISHI

COD. 77B-19-01C	UN. EMP. 10
	
BUJE BALANCIN MITSUBISHI L200/L300 Corto	
∅ Int. 15.5 mm ∅ Ext. 36.9 mm ↔ 41.4 mm	

COD. 77B-19-01L	UN. EMP. 10
	
BUJE BALANCIN MITSUBISHI L200/L300 Largo	
∅ Int. 15.5 mm ∅ Ext. 40 mm ↔ 51.5 mm	

NISSAN

COD. 77B-20-01	UN. EMP. 10
	
BUJE BALANCIN D21 / URVAN	
∅ Int. 18 mm ∅ Ext. 42.2 mm ↔ 37.7 mm	

COD. 77B-20-02	UN. EMP. 10
	
BUJE BALANCIN D21 / FRONTIER	
∅ Int. 18 mm ∅ Ext. 42.2 mm ↔ 37.7 mm	

COD. 17-20-01 OEM 54542-2S610	UN. EMP. 10
	
BUJE TIJERA DELANTERO NISSAN FRONTIER NP 300	
∅ Int. 14.2mm ∅ Ext. 45 ↔ 55.30	

COD. 17A-20-01 REF. 55045-B0700	UN. EMP. 30
	
BUJE DE BALANCIN TRASERO NISSAN 620 - 720 CAUCHO	
∅ Int. 15 mm ∅ Ext. 33 ↔ 35 mm	

COD. 17A-20-01R REF. 55045-B0700R	UN. EMP. 30
	
BUJE DE BALANCIN TRASERO NISSAN 620 - 720 CAUCHO REFORZADO CON NYLON	
∅ Int. 14.5 mm ∅ Ext. 32 ↔ 35 mm	

COD. 77B-20-04 REF.	UN. EMP. 30
	
BUJE DE BALANCIN NISSAN D-21 (RB-210)	
∅ Int. 11.5 mm ∅ Ext. 33 ↔ 70 mm	

TOYOTA

COD. 77B-24-01 OEM 90385-18009	UN. EMP. 10
	
BUJE BALANCIN TOYOTA LAND CRUISER FJ75 - BJ40 / 4.5 (80)	
∅ Int. 18 mm ∅ Ext. 47.3 mm ↔ 47.4 mm	

COD. 77B-24-02 OEM 90389-18002	UN. EMP. 10
	
BUJE BALANCIN TOYOTA LAND CRUISER (81-90)	
∅ Int. 18 mm ∅ Ext. 43.2 mm ↔ 43.8 mm	

COD. 77B-24-03	UN. EMP. 10
	
BUJE BALANCIN TOYOTA LAND CRUISER (80)	
∅ Int. 15.5 mm ∅ Ext. 33.4 mm ↔ 39.2 mm	

COD. 77B-24-04C OEM 90385-18046	UN. EMP. 10
	
BUJE BALANCIN TOYOTA HILUX / 4RUNNER 2WD - Corto	
∅ Int. 18 mm ∅ Ext. 35.5 mm ↔ 35 mm	

COD. 77B-24-04L	UN. EMP. 10
	
BUJE BALANCIN TOYOTA 2WD - Largo	
∅ Int. 18 mm ∅ Ext. 35.2 mm ↔ 48.4 mm	

COD. 17A-24-08	UN. EMP. 10
	
BUJE AMORTIGUADOR TOYOTA TACOMA MONROE	
∅ Int. 14.5 mm ∅ Ext. 37 mm ↔ 40 mm	

COD. 17A-24-01 UN. EMP. 10
REF. 90835-18025



**BUJE DE BALANCIN
LAND CRUISER HJ-45 TRASERA (75-79)
CAUCHO**

∅ Int. 17 mm ∅ Ext. 30 mm ↔ 41 mm

COD. 17A-24-01R UN. EMP. 10
REF. 90835-18025R



**BUJE DE BALANCIN
LAND CRUISER HJ-45 TRASERA (75-79)
CAUCHO REFORZADO CON NYLON**

∅ Int. 18 mm ∅ Ext. 30mm ↔ 41 mm

COD. 17A-24-04 UN. EMP. 10
REF. 90389-18001



**BUJE DE BALANCIN LAND CRUISER
BJ70 DEL Y TRAS. /HJ75 DELANTERO
CAUCHO**

∅ Int. 17 mm ∅ Ext. 35 mm ↔ 43 mm

COD. 17A-24-04R UN. EMP. 10
REF. 90389-18001R



**BUJE DE BALANCIN
LAND CRUISER BJ70 DEL Y TRAS.
HJ75 DELANTERO
CAUCHO REFORZADO CON NYLON**

∅ Int. 18 mm ∅ Ext. 35 mm ↔ 43 mm

COD. 17A-24-02 UN. EMP. 10
OEM 90385-18046



**BUJE DE BALANCIN TRASERO
HILUX TODAS LAS SERIES / ISUZU TROOPER
KB / AMIGO RODEO TODAS / CHEVY LUV
KB / AMIGO RODEO TODAS / CHEVY LUV**

∅ Int. 18 mm ∅ Ext. 30 mm ↔ 33 mm

COD. 17A-24-02R UN. EMP. 10
OEM 90385-18046R



**BUJE DE BALANCIN TRASERO
HILUX TODAS LAS SERIES / ISUZU TROOPER
KB / AMIGO RODEO TODAS / CHEVY LUV
CAUCHO REFORZADO CON NYLON**

∅ Int. 17.5 mm ∅ Ext. 29.5 mm ↔ 34 mm

COD. 17A-24-06 UN. EMP. 10
OEM 90389-14048



**BUJE AMORTIGUADOR (90389-89012)
TACOMA (95-04) / HILUX (02-09) /
4RUNNER (02-09) / JFCRUISER (06-07) /
LAND CRUISER (96-09) / TOKICO**

∅ Int. 14 mm ∅ Ext. 40.4mm ↔ 41 mm

COD. 17A-24-05 UN. EMP. 10



**BUJE AMORTIGUADOR
TACOMA - KAYABA**

∅ Int. 14 mm ∅ Ext. 35 mm ↔ 41.5 mm

COD. 17A-03-01 UN. EMP. 10
REF. 90389-14004



**BUJE HOJA RESORTE TRASERO
HILUX / MINIBUS / NISSAN**

∅ Int. 14.5 mm ∅ Ext. 40 mm ↔ 70 mm

COD. 17-00-17 UN. EMP. 10
OEM 4806136020



BUJE SUSPENSION TOYOTA COASTER / DYNA

∅ Int. 18 mm ∅ Ext. 50 mm ↑ 87 mm

COD. 17-00-18 UN. EMP. 5
OEM 4865536010



BUJE SUSPENSION TOYOTA COASTER BUS (93-03)

∅ Int. 18 mm ∅ Ext. 50 mm ↑ 62 mm

COD. 17-24-01 UN. EMP. 5
OEM 90389-16018



**BUJE BALANCIN. DEL. PTE. TRAS.
TOYOTA COASTER (98 EN ADELANTE)**

∅ Int. 16 mm ∅ Ext. 60 mm ↑ 91 mm